



## Industrial motor controller for brushed DC motors 24 VDC

Design for output currents up to 5 A

Control with the following functions:

- reversal of direction of rotation
- two adjustable speed levels
- 100% speed selectable
- adjustable start ramp (disableable)
- adjustable start ramp (disableable)
- overload detection
- short circuit detection
- dynamic brake (enableable)

To snap onto the DIN rail EN 50022

Unit width: 17,5 mm



<b>Type</b>	<b>M2-3DR-5-30</b>	
<b>Article number</b>	<b>06.34.012</b>	
<b>Operating data</b>		
Nominal voltage	$U_{nom}$	24,0 VDC
Supply voltage	$V_{CC}$	18 .. 30 VDC
Control inputs	$U_{DI}$	24,0 VDC
Quiescent current typ	$I_0$	50 mA
<b>Technical data: load circuit</b>		
Max. current / continuous load current	$I_{max}/I_{con}$	15 / 5 A
Short circuit current detection typ	$I_{SC}$	80 A
Shut-down time after short circuit typ	$t_{sc}$	100 $\mu$ s
PWM frequency	$F_s$	15,6 kHz
Duty cycle		5 .. 100 %
Power stage driver		MOS-FET
<b>Other data</b>		
Dimensions		17,5 x 70,4 x 93,0 mm
Connectors		screw terminal, pitch 5 mm cross section 0,2 – 2,5 mm <sup>2</sup>
Permissible ambient temperature	$T_{amb}$	-20 .. +50 °C
Temperature monitoring / overvoltage protection		yes / yes
Status indication: overcurrent / status		LED1 red / LED2 green
Dynamic brake (Armature short circuit)		Can be switched off

Other data	
Start ramp trimmer TR4 (start-ramp)	50 ms .. 4 s
Stop ramp trimmer TR3 (stop-ramp)	0 .. 4 s
Speed 2, trimmer TR2 (rpm2)	5 .. 100 %
Speed 1, trimmer TR1 (rpm1)	5 .. 100 %
Installation orientation / Assembly	any / top-hat rail EN 50022
Installation place, typical	Switch cabinet
Storage temperature	-30 .. +85 °C
Permissible humidity	0 to 95 %, non-condensing
Weight	0,075 kg
Start up time	2s
Hazardous substance norm	RoHS3
EMC interference immunity	EN 61326-1:2013-01 EN 61000-6-2:2005-08
EMC emitted interference, operation in industrial DC network	EN 61326-1:2013-01, Class A
EMC emitted interference, operation with power supply	EN 61326-1:2013-01, Class B
supply unit / power unit	KDR 120-24, Ott GmbH & Co. KG or comparable

Technical data: digital input	
High Signal typ.	U > 10 V
Low Signal typ.	U < 4 V
Impedance typ.	R <sub>DI</sub> 15 kΩ

Flammability	
Housing, terminals, printed circuit board	UL94V-0

**Starting behavior**  
 After applying supply voltage, the module is ready for operation when the start up time has elapsed.

**Kurzbeschreibung**  
 The M2-3DR-5-30 module is a two-quadrant motor controller with speed control for DC motors, for use in industrial environments. It ensures the switching on and off as well as the controlled driving of motors.

Two digital inputs can be used to output two preset speeds.  
 The speeds are set via two internal potentiometers.  
 If both digital inputs are controlled simultaneously, 100% speed is output.

The start ramp and stop ramp can be set separately by two potentiometers.  
 Start and stop ramp can be deactivated via digital inputs.  
 Thus the motor can be stopped both with and without dynamic brake and stop ramp.

Typical application: Standard	Typical application: PLC
-------------------------------	--------------------------

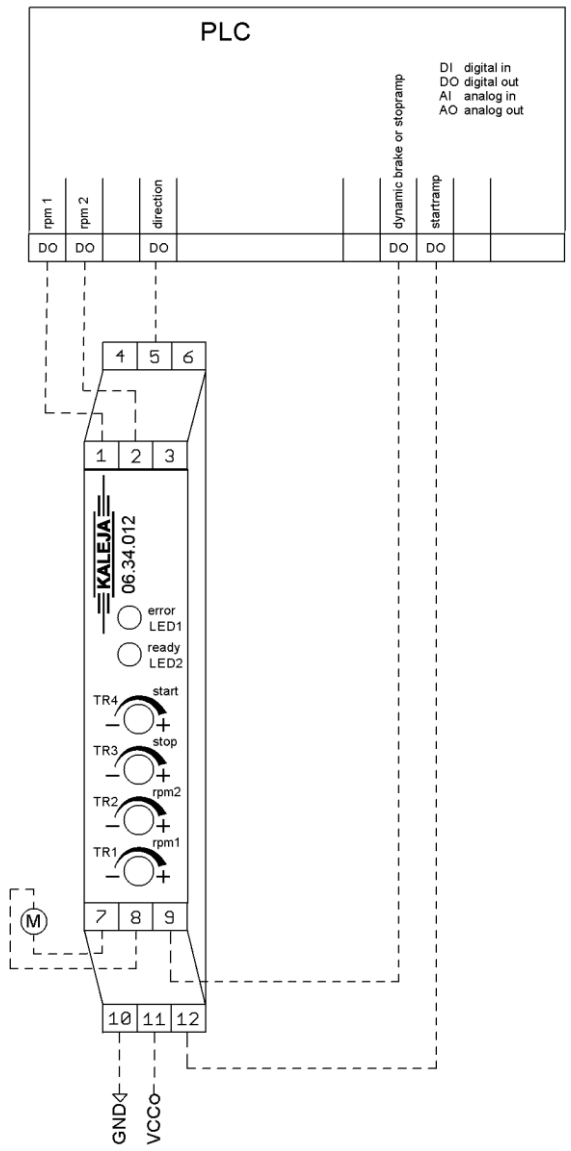
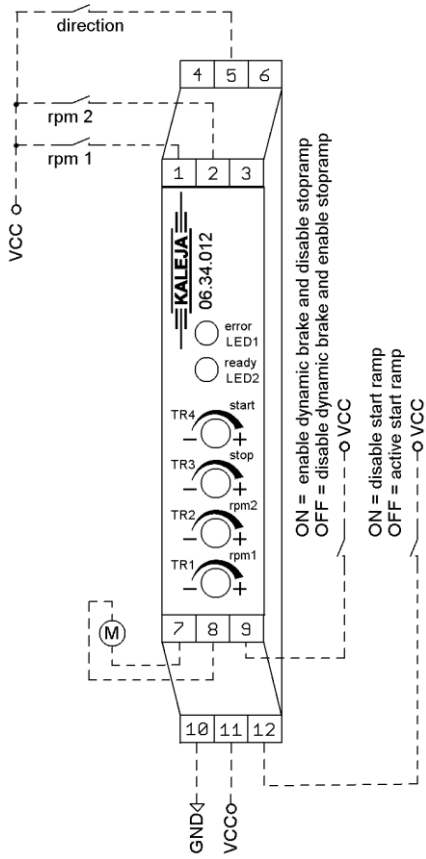

**Terminal diagram**

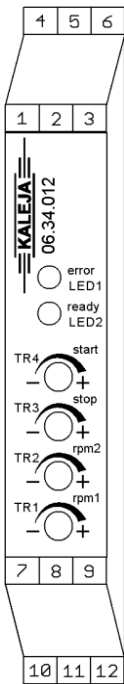









Terminal	4	5	6
Function	Reserved NC	digital input „direction of rotation“  (p- switch)	Reserved NC

Terminal	1	2	3
Function	digital input “Speed trimmer TR1”  (p- switch)	digital input “Speed Trimmer TR2”  (p- switch)	Reserved NC

Terminal	7	8	9
Function	Motor winding B	Motor winding A	digital input „100 % PWM“  (p- switch)

Terminal	10	11	12
Function	GND supply	+24 V supply	digital input “disable start ramp” (p- switch)

**State table**

Digital inputs terminal					Motor output terminal		Description
(1) Speed 1	(2) Speed 2	(5) direction of rotation	(9) stop ramp Deactivating the brake	(12) Deactivate start ramp	(7) Motor „B“	(8) Motor „A“	Legend:  1 = Vcc at terminal 0 = 0 V at terminal X = any level at terminal
1	0	0	X	X	VCC	 GND	Clockwise rotation with speed 1
0	1	0	X	X	VCC	 GND	Clockwise rotation with speed 2
1	1	0	X	X	VCC	 GND	Clockwise rotation with speed 100%
1	0	1	X	X	 GND	VCC	Anticlockwise rotation with speed 1
0	1	1	X	X	 GND	VCC	Anticlockwise rotation with speed 1
1	1	1	X	X	 GND	VCC	Anticlockwise rotation with speed 100%
X	X	X	X	0	 GND	VCC	Startramp <b>active</b> at start and speed increase
X	X	X	X	1	 GND	VCC	Startramp <b>not active</b> at start and speed increase
0	0	X	0	X	Open at the end of the stop ramp		Stop ramp <b>active</b> at stop and speed reduction, Dynamic brake <b>not active</b>
0	0	X	1	X	Immediately on GND		Stop ramp <b>not active</b> at stop and speed reduction, Dynamic brake <b>active</b>

Function: Rotation speed control	Function: Start ramp
----------------------------------	----------------------

Trimmer TR1 and trimmer TR2 can be used to set two separate speeds between 5% and 100% PWM.  
 If there is a high signal at terminal (1), the speed of trimmer TR1 is output.  
 With a high signal at terminal (2), the speed of trimmer TR2 is output.  
 With a high signal at terminal (1) and at terminal (2), speed 100 % PWM is output.

Über den Trimmer TR4 kann die Steigung der Startrampe eingestellt werden. Die Steigung definiert sich als Zeit von Start bis 100% Drehzahl.  
 The trimmer TR4 can be used to set the slope of the start ramp. The gradient is defined as the time from start to 100% speed.  
 A speed increase from a lower to a faster speed also occurs with ramp.  
 The start ramp can be reduced to the minimum value of 5% via the digital input at terminal (12).

Function: dynamic brake / stopramp	Function: overcurrent shut-off / current limitation
------------------------------------	---

The trimmer TR3 can be used to set the slope of the stop ramp. (The gradient is defined in the same way as described for the start ramp).  
 A speed change from a faster to a slower speed also takes place with ramp.  
 The stop ramp can be deactivated via the digital input at terminal (9). At the same time, the "dynamic brake" function is activated.  
 If the dynamic brake is active, the motor winding is switched to GND at both terminals when stopping. The motor is stopped with armature short-circuit.

In case of overload or short circuit, the motor switches off without dynamic brake. The motor can be restarted by resetting the device or re-setting the speed (terminals (1) or (2)).

Translated with [www.DeepL.com/Translator](http://www.DeepL.com/Translator)

Device status	Display elements
---------------	------------------

The module status is displayed via LED´s on the module front.

LED1 red	LED2 green	meaning
Off	On	Module is operational
On	flashing	Module error 1 (see table)
flashing	flashing	Internal Error

Module errors are displayed as flashing sequences. The end of the sequence is indicated by a pause of 1 second.  
 The number of flashes indicates the error number.

Module error 1

1	overcurrent
2	Over-temperature
3	short circuit detected
4	overvoltage
5	overload
6	Under-temperature
7	Low supply voltage
8	

Dimensional drawing

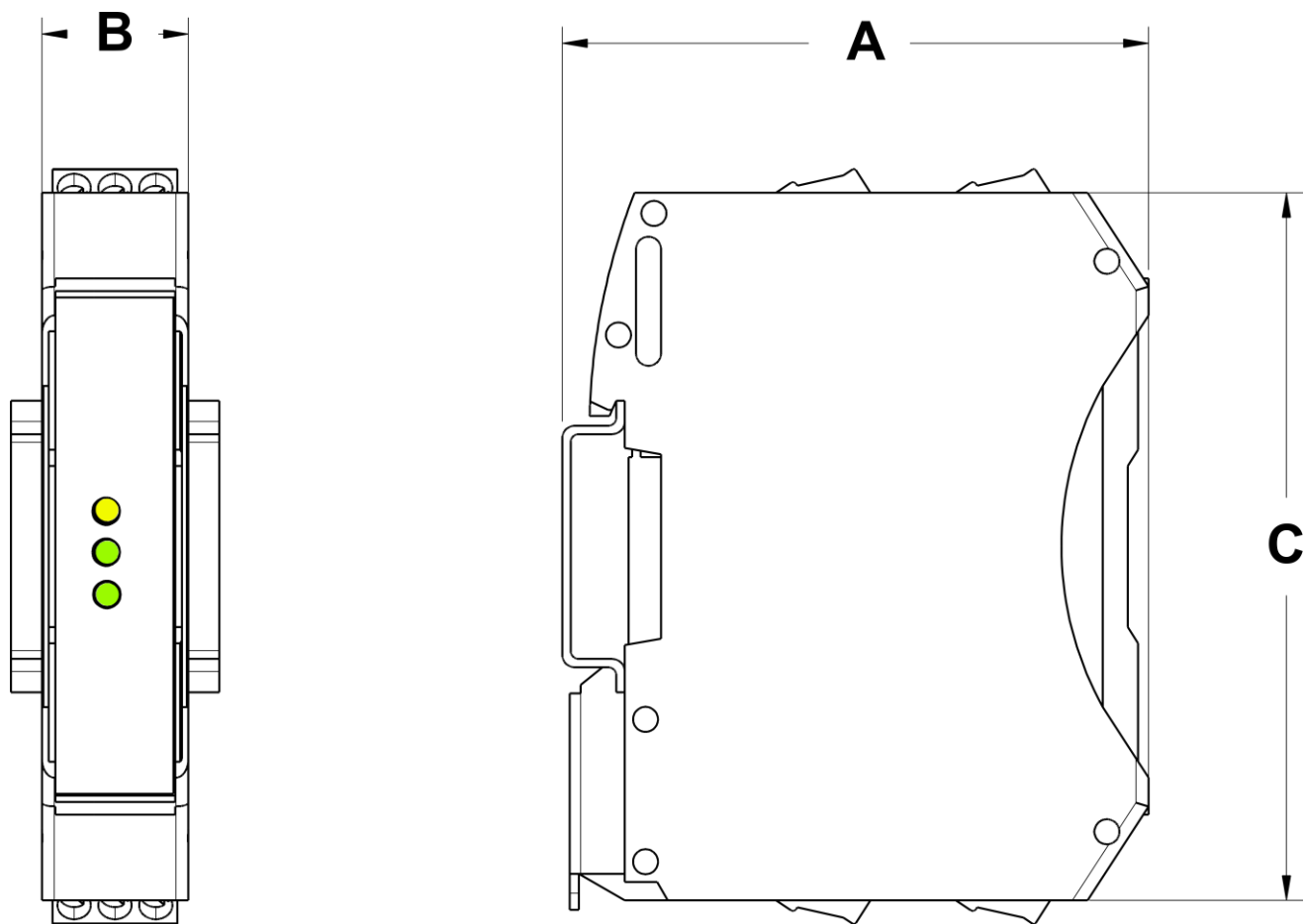

A = 70,4 mm; B = 17,5 mm; C = 85 mm

## Safety notes

### Maximum operational data

The maximum operating data must not be exceeded.

### Installation

The installation and start-up must be performed by specialist personnel exclusively.

All affected components must be disconnected from the mains.

### Start-up

For the first start-up, the motor should be operated without load.

### Risk of death

Do not touch live parts after switching on!

The assembly must be operated exclusively on safety extra-low voltage. With operation on extra-low voltage (e.g. via autotransformer), death or injury can occur.

### Fire protection

The assembly must be installed in a switch cabinet, which is suitable as a fire protection enclosure.

The assembly must be safeguarded with a pre-fuse aligned with the nominal data.

### Field of application

The assembly may only be used as intended.

Other components must be checked for their approvals and regulations.

### Safety devices

An additional safety device must be used to bring the system into a safe state in case of a cable break, incorrect operation, failure of the control/controller unit.

### EMC / EMI

The wiring must be done according to EMC / EMI standards. If necessary, shielded cables and EMC suppressors must be used for the connected consumer.

For operation in a public low-voltage distribution network, the module must be supplied with an approved AC adapter.

If the module is supplied with an AC adapter, other equipment, operated on the same power supply, must be suitable for use in industrial environments.

### Repairs

Repairs must be performed by authorised persons exclusively. With unauthorised opening, the warranty cover is voided and this may also result in danger for the user and for the system.

### Maintenance

The assembly is wear-free by design.

For modules **with** cooling openings free air circulation must be checked at the cooling openings or on the housing at regular intervals. If necessary, the cooling holes / the housing must be cleaned.

Good ventilation must be ensured.

## contact details



ready-to-use motor control solutions  
electronics design & manufacturing

### KALEJA GmbH

Strübelweg 14

D-73553 Alfdorf, Germany

Tel: +49 7172 93711 0

Fax: +49 7172 93711 90

E-Mail: [info@kaleja.com](mailto:info@kaleja.com)

[www.kaleja.com](http://www.kaleja.com)